

Narrowband PMD Measurements with the Agilent 8509C

Product Note 8509-2

A guide to making PMD measurements on narrowband devices using the Agilent 8509C Lightwave Polarization Analyzer

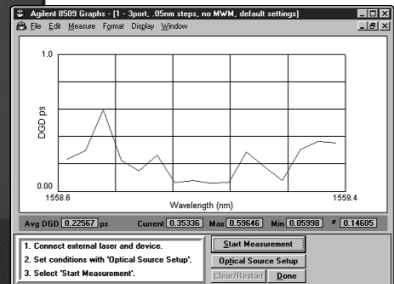
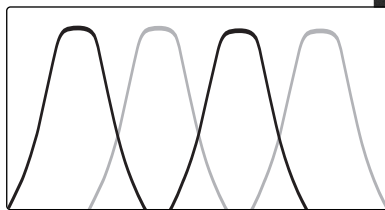

Agilent Technologies

Innovating the HP Way

Table of contents

I. Introduction3
II. PMD in Narrowband Devices4
III. Narrowband PMD Measurements Using the Agilent 8509C6
A. Environmental and basic setup considerations6
B. Optical source considerations7
C. Device under test (DUT) considerations7
D. Measurement preparation9
E. Making measurements11
Appendix 1: Improving PMD Measurements with the Agilent 86120C Multi-Wavelength Meter14
Appendix 2: PMD Measurement Verification Using a Calibrated Reference Device16
Appendix 3: Comparison of PMD Measurement Techniques for Narrowband Applications17

I. Introduction

This product note provides information about making narrowband polarization mode dispersion (PMD) measurements using the Agilent 8509C lightwave polarization analyzer. The term “narrowband”, as it applies to this document, refers to PMD analysis in devices where the wavelength range is on the order of 1 nm or less. Dense wave division multiplexing (DWDM) systems require the use of these narrowband devices. They are implemented through several technologies, such as thin film, array wave guide (AWG), and fiber Bragg gratings. DWDM technology combined with ever-increasing data rates has created the need to characterize low levels of PMD in narrowband devices.

II. PMD in Narrowband Devices

Polarization mode dispersion can limit fiber optic transmission performance. It is caused by natural or induced birefringence in the optical transmission medium, which in turn causes polarization components of a signal to travel at different group velocities. This is shown in Figure 1. The relative delay between the two polarization modes is called differential group delay (DGD), typically denoted by $\Delta\tau$. Units are picoseconds (ps) for components and short fiber lengths and $\text{ps}/\text{km}^{1/2}$ for long fiber.

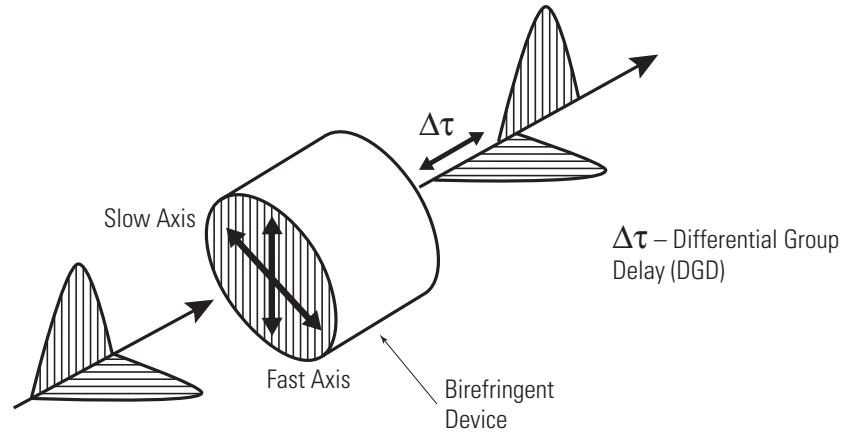

Figure 1. Schematic representation of PMD

As data rates increase, the impact of PMD increases. This is illustrated in Figure 2. As the bit period of a digital optical pulse becomes smaller, polarization mode delay represents a greater portion of a bit period. There may be relatively minor effects on a 2.5 Gb/s signal while 10 and 40 Gb/s signals may suffer increased jitter and degraded bit error rate (BER). To maintain data transmission integrity, it is important to keep overall DGD within 10 to 20% of the bit period of a signal. With this in mind, Figure 3 indicates acceptable PMD for various data rates.

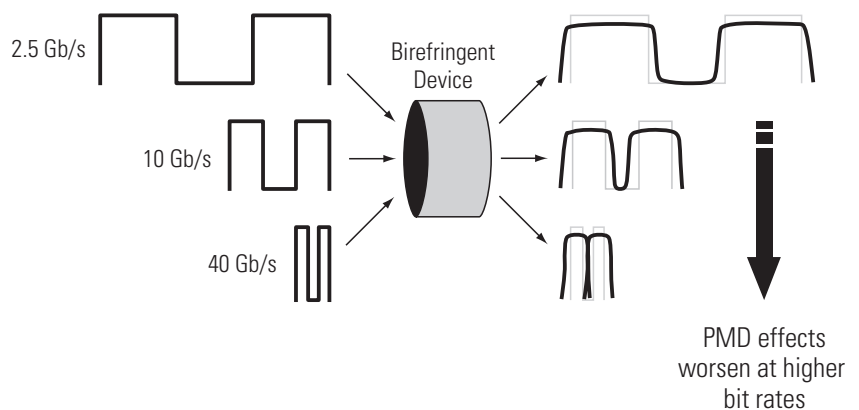

Figure 2. PMD sensitivity to higher bit rates

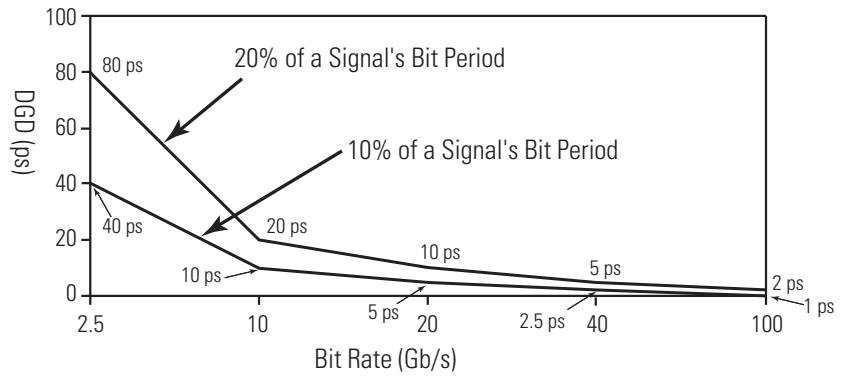

Figure 3. Acceptable PMD for various bit rates

DWDM technology increases the number of optical elements in the signal path (WDM MUX and DEMUX devices). Higher data rates require that PMD must be analyzed in these components, and due to the narrowband nature of DWDM, PMD must be measured over small wavelength ranges. Figure 4 shows a sample transmission response of a six channel WDM DEMUX device with 100 GHz spacing. Characterizing PMD on each channel ensures that the overall system can be designed and manufactured to perform in fiber optic networks. The Agilent 8509C is an important tool that provides PMD measurement solutions for both broadband and narrowband devices. This document, however, specifically addresses making measurements on narrowband devices and components.

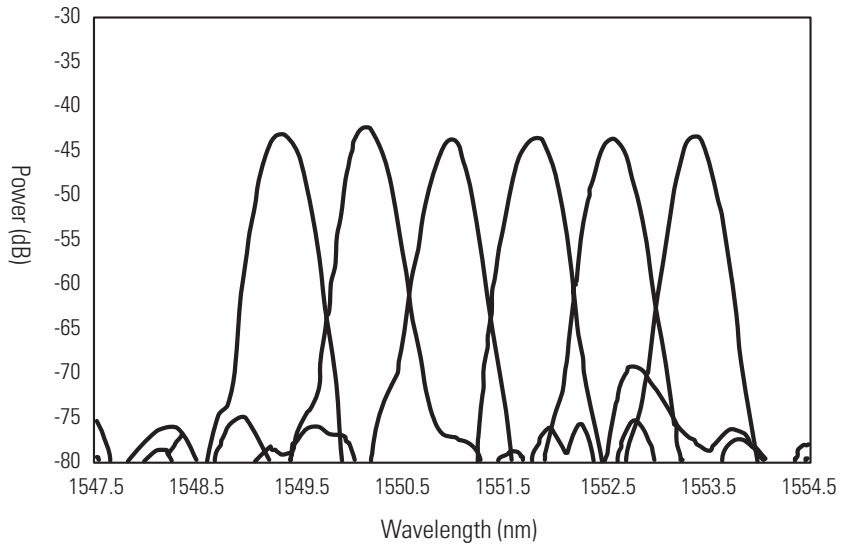

Figure 4. Sample narrowband filter device

III. Making Narrowband PMD Measurements Using the Agilent 8509C Lightwave Polarization Analyzer

A. Basic Setup and Environmental Considerations

When making narrowband PMD measurements, setup and environmental factors can significantly affect results. It is critical to understand those conditions that can influence measurement accuracy and repeatability so that measures can be taken to address them. Some key concerns are mentioned here along with recommended steps to minimize their impact.

Reflection

Optical reflections of a signal can cause interference resulting in distortion and unstable polarization modes. When severe, they can cause erroneous PMD measurements. One possible indication that reflections are present in the measurement path is the presence of polarization state drift in the Poincaré Sphere, even while the testing environment is stationary (Figure 5). Details can be seen on the sphere in the 8509C main window by pressing the [s] button in the marker area and pressing the [Zoom] button.

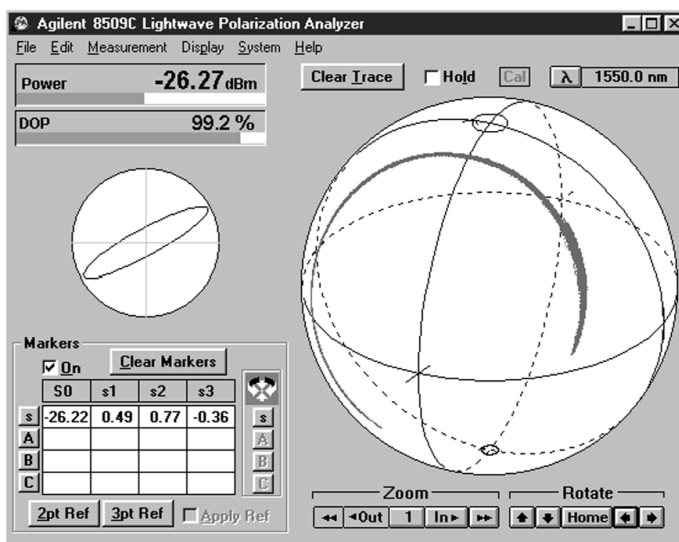

Figure 5. Drift in polarization due to reflections

Ideally, the SOP would remain static on the sphere when the test configuration is unperturbed. If it is not stationary, then there is a potential source of reflection along the test path which should be eliminated or minimized before measurements can be made. Areas to examine are dirty or loose connector interfaces, fiber patch cords with sharp bends or possible internal fractures, or reflections in the device under test itself. Fiber Bragg gratings, for example, require appropriate terminations (such as tightly wrapping fiber in small loops or around a pencil) to minimize reflections. The optical source should be checked to verify that it is on and that sufficient output power is produced.

Temperature and Vibration

The test environment can have substantial effect on PMD measurements. Thermal and mechanical stress caused by temperature variations and fiber/DUT movement can have a direct effect on PMD measurements, especially when measuring devices with small DGD. To minimize their effects, testing should be performed in an area where temperature is stable and where vibration or susceptibility of fibers to movement is minimized. It is also good practice to tape down the fiber pigtailed to the work surface, and avoid creating sharp bends during this procedure.

B. Tunable Laser Source Considerations

An Agilent 81640A tunable laser source (TLS) is required to make PMD measurements with the 8509C in the L-band. In the 1550 nm range, several sources are available, but the Agilent 8168F version is recommended for narrowband applications. It combines a wide wavelength range and good tuning linearity necessary for small wavelength steps. If step sizes smaller than 0.1 nm are used, then an Agilent 86120C multi-wavelength meter is required for improved measurement accuracy and repeatability. Information on how to use the 86120C is discussed in subsequent sections and Appendix 1.

C. Device under test (DUT) considerations

It is important to understand the optical properties of the narrowband device before measurements are made. Unlike fiber, which is very broadband, narrowband devices severely limit the source spectrum. The amplitude response of a 100 GHz narrowband filter is depicted in Figure 6. The 3dB bandwidth is about 0.5 nm. An optical spectrum analyzer (OSA) such as an Agilent 8614xB or the 8509C (with a tunable source) can be used to obtain this information. The wavelength limits of the passband must be supplied to the 8509C during the setup procedure so that the appropriate range is evaluated. The expected bandwidth value is also useful to determine initial wavelength step sizes when making measurements. This topic is covered in measurement preparation.

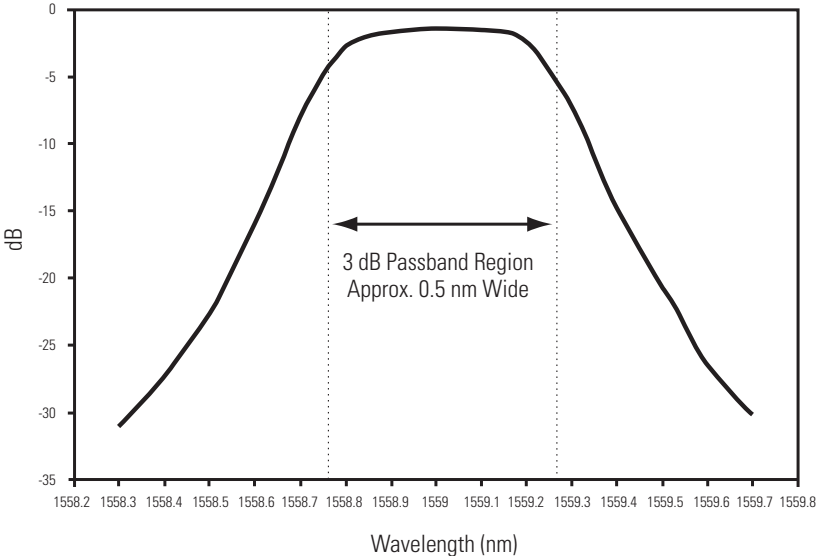

Figure 6. Narrowband filter response

The loss characteristic is another important consideration for devices. If the device is very lossy in certain portions of the spectrum, the received power may fall below the range of the 8509C's wideband detectors (-55 dBm). For example, the notch rejection band of a fiber Bragg grating cannot be examined due to high signal rejection in that region. The optical source should be adjusted so that the power received is within the 8509C's measurable range. The power bar display (Figure 7) available in the main window shows the signal's input power received.

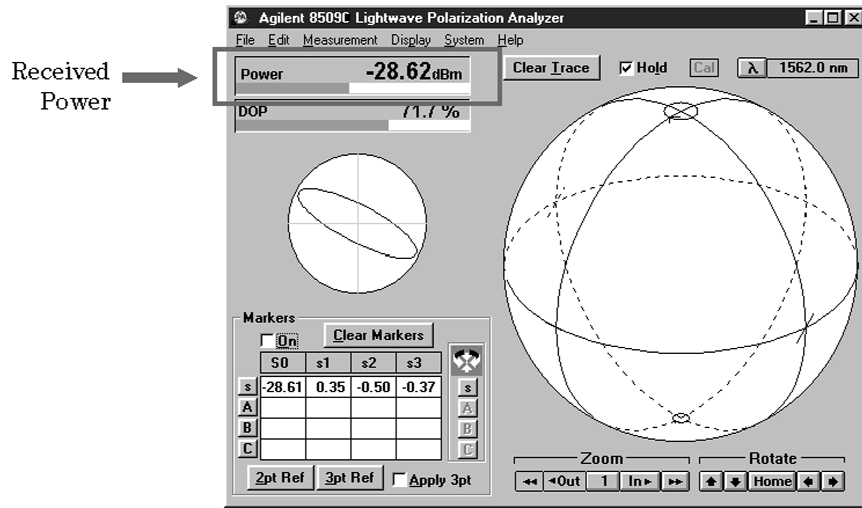

Figure 7. Agilent 8509C - power display

Finally, ensure that the device under test does not depolarize the optical signal. This concern applies mainly to the measurement of erbium doped fiber amplifiers or EDFAs. If the EDFA does not operate at full saturation, the ASE contribution of the signal can reduce the degree of polarization of the signal. This can in turn affect PMD results if the signal's polarization is too low. To test how much the device depolarizes a signal, connect a laser source into the device, and examine the output in the Agilent 8509C. The DOP bar in the main window (Figure 8) shows the degree of polarization, and it is recommended that the signal be at least 80% polarized.

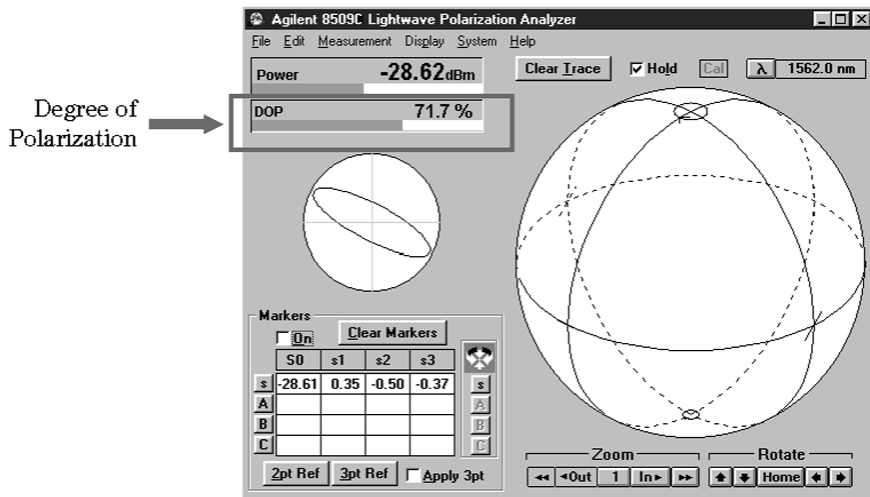

Figure 8. Agilent 8509C - DOP display

D. Measurement Preparation

Make the optical and GPIB connections between the 8509C, 8164X or 8167/68X TLS, and 86120B/C multi-wavelength meter, as shown in Figure 9. Note that a coupler is needed by the 86120 to sample the TLS wavelength.

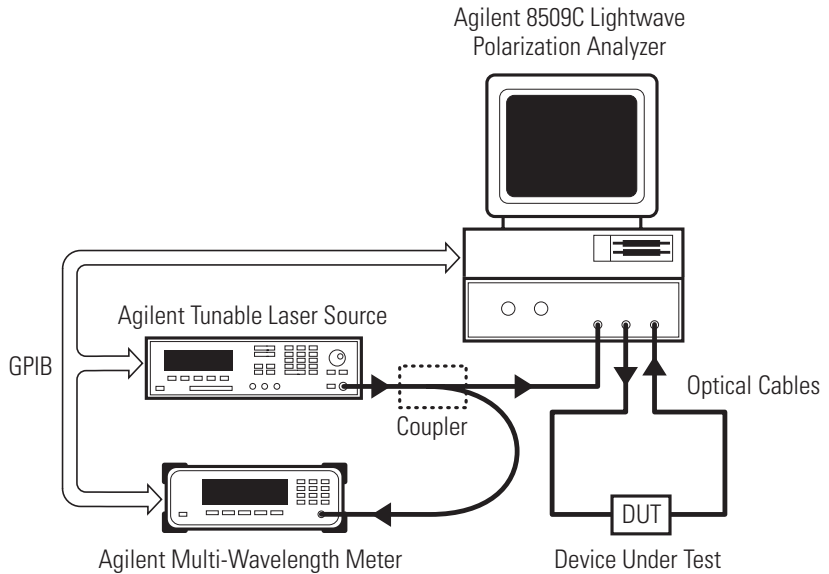

Figure 9. Agilent 8509C narrowband PMD measurement configuration

Follow the basic PMD measurement procedures defined in the 8509C product manual from pages 2-2 through 2-7. The summary is provided below:

1. Set optical source to desired wavelength
2. Be sure that the Polarizers in the **[System]** menu are set to **Internal**
3. Connect a fiber pigtail from the **Optical Output** directly to the **Optical Input**
4. Select the **[3pt Ref]** button from the Markers Area in the main window and wait 5 seconds
5. Select **[Apply 3pt]**
6. Adjust the External Source Polarization knobs so that the **s3** marker value is greater than **0.90**
7. Remove the 3pt reference by re-selecting **[Apply 3pt]**
8. Connect the device under test (DUT) between the **Optical Output** and **Optical Input**

In the main 8509C window, select **[Measurement]** in the pull down window, and choose **[PMD: Jones Matrix Eigenanalysis]**¹. Choose the appropriate optical source and GPIB address in the optical source selection area. Verify that the power button is set to **[ON]** and set the tunable laser source to generate the maximum amount of power². Next, choose the start and stop wavelengths that correspond to the passband region of the device under test. The next few paragraphs describe step size considerations.

¹ The wavelength scanning technique cannot be used for narrowband measurements.

² The maximum power received by the 8509C detectors should not exceed +10 dBm.

Setting wavelength step size

Determining appropriate wavelength step size for a test device is not always easy, particularly in narrowband applications. The common belief is that one can use arbitrarily small step sizes, but there are limits to consider. A key constraint is source wavelength accuracy. As step sizes get smaller, the measurement becomes more sensitive to small wavelength errors. This is explained by the following equation used in the Jones Matrix analysis:

$$\Delta\tau_i = \left| \frac{\kappa_i}{\Delta\omega_i} \right|$$

where $\Delta\omega_i$ is the i^{th} frequency step of a PMD measurement, corresponding to wavelength step $\Delta\lambda_i$. The value κ_i is determined by eigenanalysis of the Jones matrices measured at either end of wavelength interval $\Delta\lambda_i$. The value of DGD corresponding to interval $\Delta\lambda_i$ is given by $\Delta\tau_i$. An erroneous DGD value is reported when $\Delta\omega_i$ in the denominator does not match the change expected by the 8509C due to small wavelength error in interval $\Delta\lambda_i$.

An example of how wavelength errors affect PMD measurements is depicted in Figure 10. Trace A shows a measurement using 0.025nm steps without wavelength correction. The DGD trace is erratic and unrepeatable. Trace B shows the same measurement with wavelength correction using an 86120C multi-wavelength meter. The result is a more uniform and reproducible trace, highlighting the benefits and importance of using accurate wavelengths. The 8509C is designed to work in concert with the 86120C to improve wavelength accuracy. Further information on setting up and using the 86120C is available in Appendix 1.

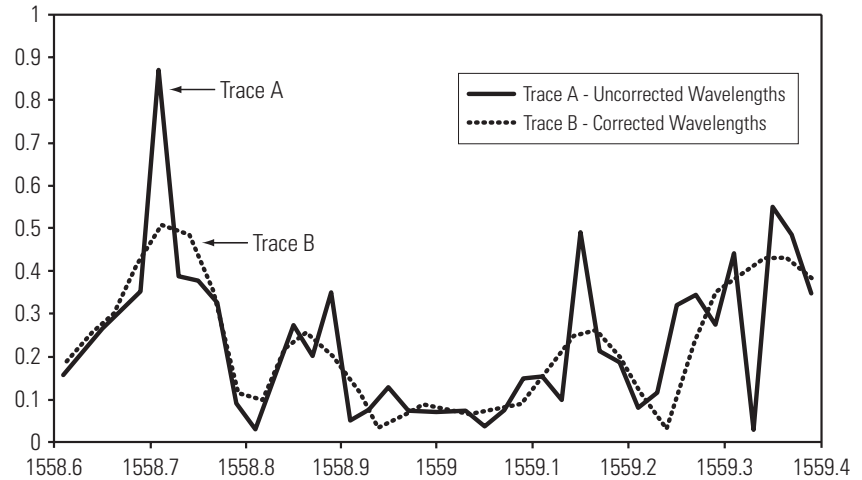

Figure 10. How wavelength error affects PMD measurement

Since narrowband devices require small step sizes, begin with wavelength steps that generate **5 to 10** points to obtain a coarse first measurement. The step size can be reduced in subsequent iterations to provide greater DGD detail of the device. The **[Number of points]** parameter in the Optical Setup window will be automatically populated based on step size. Select **[Done]** to close the window. Do not use the **[Find Minimum # of points]** feature for narrowband measurements.

Finally, step size is dependent on the amount of PMD present in the device under test. In order to prevent aliasing (i.e., greater than 180 degree rotation around principal state of polarization axis), the step size is bound by the equation $\Delta\tau \times \Delta\lambda \leq 4.0 \text{ps} \cdot \text{nm}$ in the 1550 nm range. Devices with high $\Delta\tau$, or DGD, will require sufficiently small step sizes ($\Delta\lambda$) such that the expression is satisfied, to avoid aliasing.

E. Making Measurements

Iterating Measurements

Once the optical setup is complete, press the **[Start Measurement]** button on the JME graph window. The 8509C will control the TLS to step through the wavelength range and display the resulting DGD vs. wavelength trace. Once a measurement is complete, the average DGD and other statistical data will be displayed below the trace. A sample measurement is depicted in Figure 11.

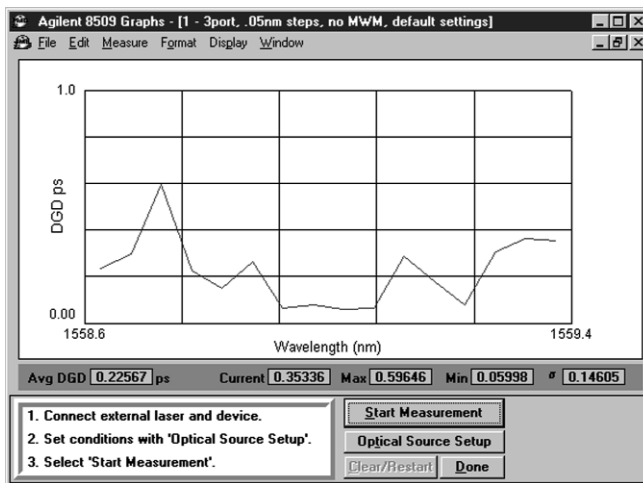

Figure 11. PMD Measurement result

Go to the **[Window]** pull down menu and select **[New JME Window]** to repeat the measurement. In the Optical Setup window, reduce the step size (by 25 or 50 percent, for example) and repeat the measurement. As this process is iterated, each trace should produce greater resolution than previous results. Figure 12 shows results of three subsequent measurements using this approach.

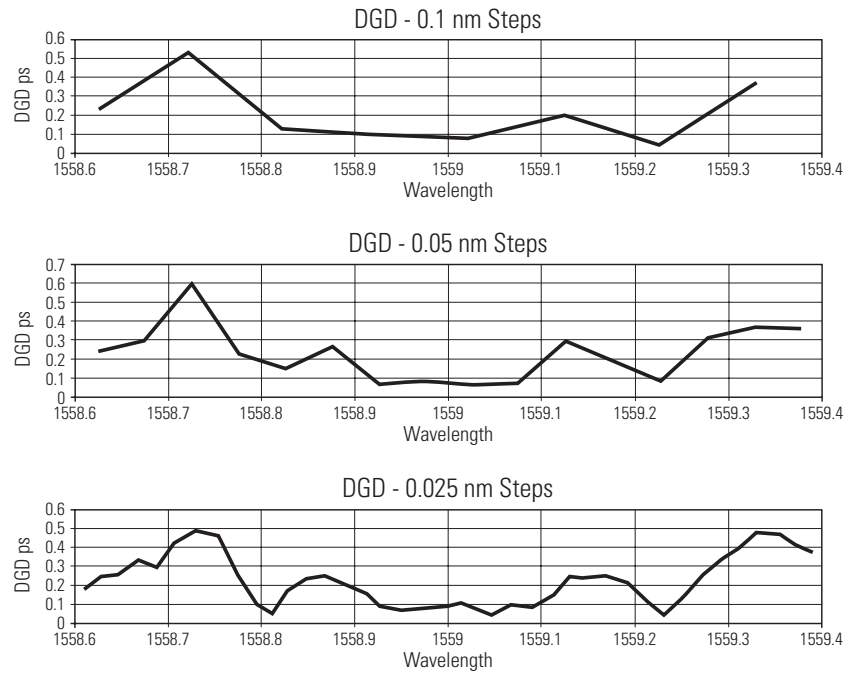

Figure 12. Three measurements using different wavelength step sizes

There are, however, some limits as to how small the step sizes can be. The 8509C application limit is .005 nm steps. Although the 86120C has wavelength accuracy better than 0.003 nm, the algorithm that controls the multi-wavelength meter only requires that the wavelength be within 0.005 nm of the target value. Devices with small differential group delay can also limit the lowest workable step size. When there is no appreciable polarization state change per small wavelength step, then results are prone to some error. Other conditions, such as environmental changes and instrument detector noise, can limit the lowest workable step size. This is because the uncertainty of the Poincaré sphere measurement becomes significant compared to the movement caused by device PMD and the wavelength step.

Interpreting Results

Once a series of measurements has been made, they can conveniently be examined on a single chart. In the [PMD Statistics] menu, choose [File] in the pull down menu and select [Add from Selected JME window]. Load additional traces by going back to the JME graph window, selecting a different trace, and returning to the PMD Statistics window. Go to the pull down menu and choose [Add from Selected JME window] again. An overlay of multiple traces will be shown (Figure 13). This provides a fast and convenient way to compare traces without leaving the 8509C application. Since narrowband devices typically are not mode-coupled, the bottom trace showing the Maxwellian curve fit can be ignored. The DGD data can also be exported to another application (such as a spreadsheet program) for further analysis, annotation, and graphing.

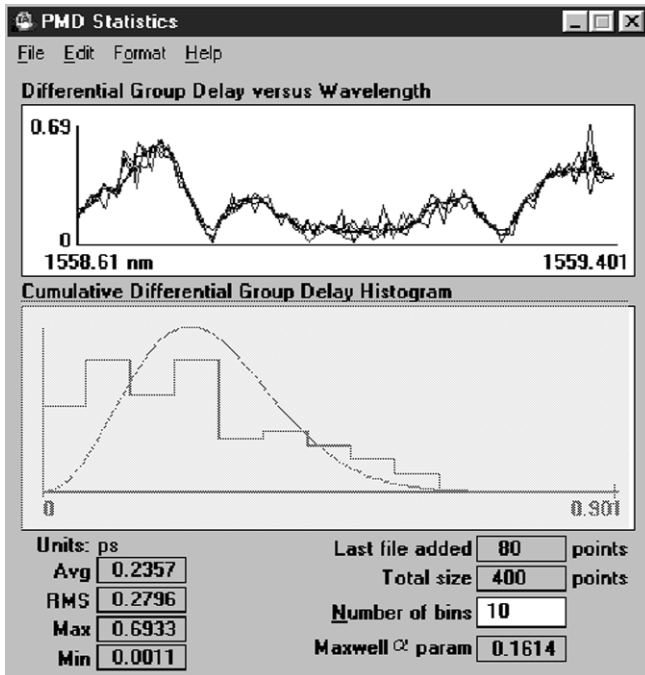

Figure 13. PMD statistics window

Adjusting System Averaging

The 8509C computes several thousand Stokes values per second. At each measurement point, consecutive normalized Stokes values are averaged before they are passed to the Jones Matrix algorithm. The system default is 250 samples per point. In some cases (e.g., noisy environments, low optical power or low DOP), accuracy and repeatability may be improved by increasing the amount of averaging. There is a time penalty of a few seconds per step if more than 1000 points are used. To change the system averaging, go to the [System] pull down menu in the main 8509C window and select [Averaging]. Adjust the number of *measurement* averages to the desired value. Select [Done]. Subsequent measurements will use the new average parameter.

Summary of Steps

1. Set up PMD test station in temperature- and vibration-stabilized area
2. Determine wavelength range of device to be tested
3. Make all optical and GPIB connections (use a multi-wavelength meter if < 0.1 nm steps)
4. Set up optical source and measurement parameters
 - 4a. Adjust TLS power of Agilent tunable source to maximum
 - 4b. Set start and stop wavelengths of device
 - 4c. Start with step sizes that generate 5-10 measurement points
5. Make measurement
6. Repeat with smaller step sizes³
7. (Optional) Adjust system averaging for possible measurement improvement
8. Store and analyze results

³ Record measurement parameters for use in manufacturing test of similar devices.

Appendix 1: Improving PMD Measurements With the Agilent 86120C Multi-Wavelength Meter

An Agilent 86120C multi-wavelength meter is required when wavelength step sizes below 0.1 nm are used. The “C” version can achieve absolute wavelength accuracy of 0.003 nm⁴. The diagram for connecting the multi-wavelength meter to the PMD testing configuration is shown in Figure 9.

The 8509C is designed for automated PMD measurements with the 86120C. During operation, the wavemeter receives a coupled portion of the TLS signal. The 8509C calls for a target wavelength and reads the wavelength measured by the multi-wavelength meter. If they are not in agreement, the TLS is directed to adjust the wavelength until it is within .005 nm of the target⁵. The normalized Stokes values and the 86120’s wavelength value are passed to the JME algorithm for a DGD computation.

In order to use the 86120C, the 8509C software version must be **A.02.10** or higher running under Windows[®] 95. The software version can be determined by going to the [Help] pull down menu in the main 8509C application window and selecting [**About 8509C...F1**]. If the version is lower than A.02.10, a software upgrade option⁶ is available by contacting Agilent.

If the version number is correct, a configuration file may need to be modified to enable control of the multi-wavelength meter. To examine the configuration file, exit all applications and open the [My Computer] icon in the workspace area. Access the C: drive and go to the **8509_2** directory (or the directory where the most current application resides). Load the file **8509.cfg** to a text editor program, and scroll down to the line [**wlenmetermenushow={0 or 1}**]. If this value is a **0**, change it to **1**, and save the file and exit. Reload the 8509C application.

From the main 8509C window, choose [**Measurement**] and [**PMD: Jones Matrix Eigenanalysis**] in the pull down menu. Set the desired parameters in the optical setup menu, and exit the optical setup by pressing [**Done**]. In the [**Measure**] pull down menu, select [**Use Wavelength Meter**] near the bottom of the pull down menu (Figure 14)⁷.

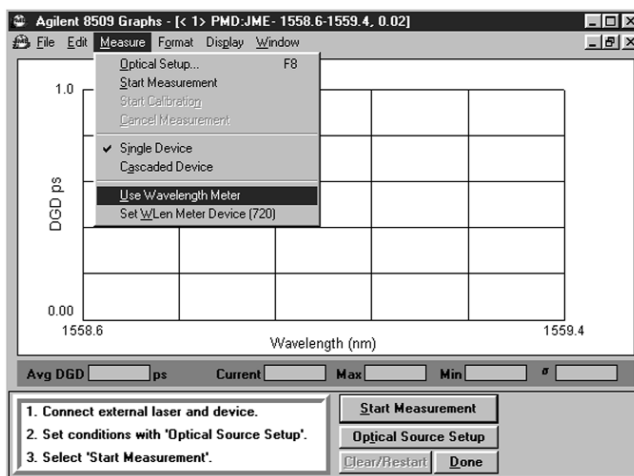

Figure 14. Wavelength meter option in the PMD JME window

⁴ Accuracy using Agilent 86120C. The 86120C provides at least 0.005 nm absolute accuracy.

⁵ If after a certain number of tries for <.005nm, the 8509C routine will use the last attempt made by the TLS.

⁶ Contact an Agilent field engineer or local call center for details.

⁷ Be sure that the GPIB address of the wavelength meter in the 8509C matches that of the instrumentation.

Windows is a U.S. registered trademark of Microsoft Corporation.

A **[WL Meter]** indication will appear near the bottom of the graph window as shown in Fig.15. This indicates that the multi-wavelength meter is ready to provide a wavelength reference for measurements.

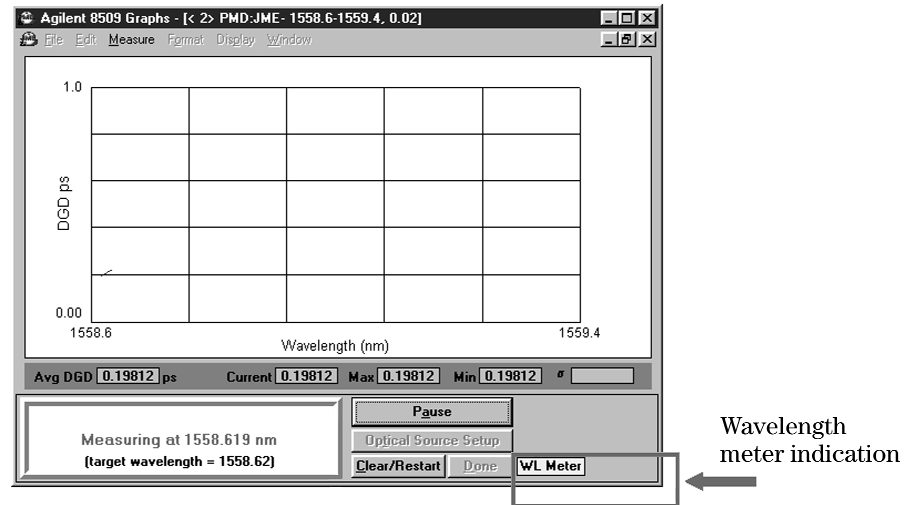

Figure 15. Wavelength meter indication

When a measurement is initiated, a **[Target Wavelength]** is displayed along with the value that is measured by the 86120C (Figure 16). The TLS will be re-tuned if the measured wavelength is off the target value by more than 0.005 nm. Using the 86120C multi-wavelength meter will add a few seconds to the measurement time at each wavelength step.

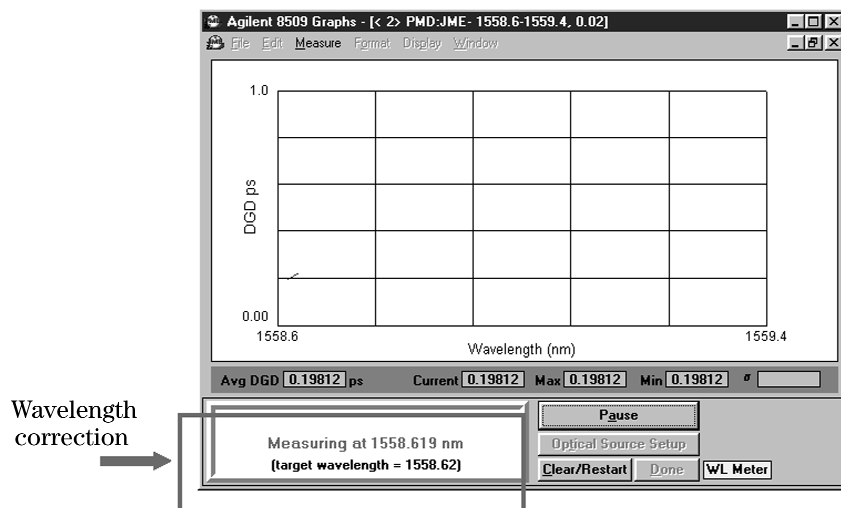

Figure 16. Target wavelength vs. measured wavelength

Appendix 2: PMD Measurement Verification Using a Calibrated Reference Device

When making PMD measurements, it is often useful to verify the performance of the instrument before making measurements on the actual device. A quartz waveplate (see Figure 17) with a stable, known amount of PMD over a wide wavelength range is a highly effective way to validate a PMD analyzer's performance⁸. Various DGD values are available, from tens of femtoseconds to tenths of picoseconds. Packaging can also vary from connectorized packages to bulk devices for open beam launch. Using this calibrated device improves confidence that measurements on the actual DUT will be accurate.

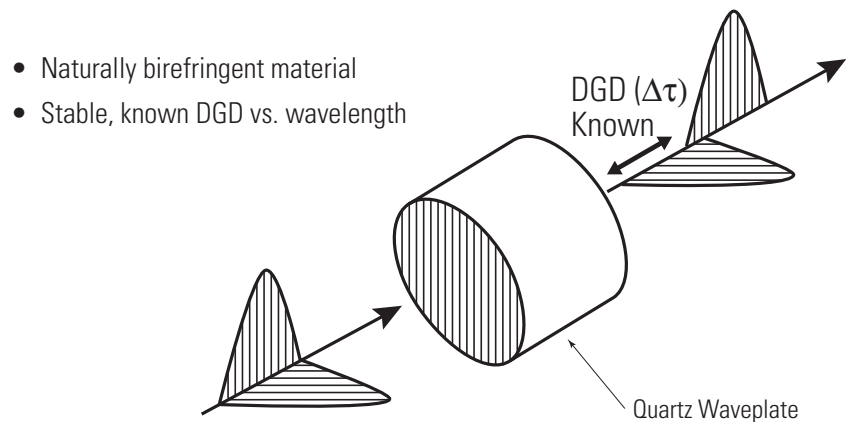

Figure 17. Diagram of quartz waveplate PMD reference

The setup for measuring the reference material with the 8509C is identical to that used for the actual device under test as described in Section III. The wavelength range and step size parameters should also be the same as those that will ultimately be used on the DUT. After a measurement is made, the average DGD result should be within a few femtoseconds of the DGD value specified by the waveplate⁹. Small differences are normally caused by the PMD contribution of fiber pigtails used in the measurement. Pigtail effects can be reduced by making multiple measurements and changing the lay of the fiber cords that are connected to the DUT (or randomizing polarization using a polarization controller) before each measurement run. The fibers should be secured before each measurement is initiated, and they should not be moved while the measurement is underway. When the traces are averaged, the DGD of the fiber should be cancelled out to a first order.

After the reference device has been measured with acceptable results, measurements can begin on actual DUTs.

⁸ These devices can be obtained from various vendors. The National Institute of Standards and Technology (NIST) provides a calibration service for the single waveplate type of PMD standard. NIST also offers a highly mode-coupled standard reference material (SRM-2518) consisting of a stack of waveplates. Its DGD varies with wavelength.

⁹ There may be step size limitations with waveplates that have very small levels of PMD (e.g., 50fs or less).

Appendix 3: Comparison of PMD Measurement Techniques for Narrowband Applications

PMD measurements can be made using a variety of techniques. For narrowband applications, however, some methods do not work. The following table describes commercially available PMD measurement techniques and their applicability to narrowband measurements.

Measurement Technique	Description	Capable of Narrowband Measurements?	Provides DGD vs. Wavelength?	Optical Source type (TLS - Tunable Laser Source, BBS - Broadband Source)
Jones Matrix Eigenanalysis (TIA FOTP-122) ¹⁰	Determines DGD from analysis of Jones matrices measured at closely spaced pairs of wavelengths.	Yes	Yes	TLS
Modulation Phase Shift	Determines DGD from the modulation phase difference of light propagating in the two principle states.	Yes	Yes	TLS
Poincaré Arc Method	Determines DGD from the rate of rotation of the output state of polarization about the principal states axis.	Yes	Yes	TLS
Wavelength Scanning or Fixed Analyzer (TIA FOTP-113)	Average DGD is determined from the density of peaks and valleys in the transmission through a polarizer.	No	No	TLS with polarimeter (or power meter) or BBS with optical spectrum analyzer
Interferometry (TIA FOTP-124)	Average DGD is determined from the interferogram of a Michelson Interferometer.	No	No	BBS

¹⁰ TIA = Telecommunications Industry Association. Fiber Optic Test Procedures (FOTPs) can be purchased from Global Engineering Documents at (800) 854-7179.

Agilent Technologies'

Test and Measurement Support, Services, and Assistance

Agilent Technologies aims to maximize the value you receive, while minimizing your risk and problems. We strive to ensure that you get the test and measurement capabilities you paid for and obtain the support you need. Our extensive support resources and services can help you choose the right Agilent products for your applications and apply them successfully. Every instrument and system we sell has a global warranty. Support is available for at least five years beyond the production life of the product. Two concepts underlie Agilent's overall support policy: "Our Promise" and "Your Advantage."

Our Promise

Our Promise means your Agilent test and measurement equipment will meet its advertised performance and functionality. When you are choosing new equipment, we will help you with product information, including realistic performance specifications and practical recommendations from experienced test engineers. When you use Agilent equipment, we can verify that it works properly, help with product operation, and provide basic measurement assistance for the use of specified capabilities, at no extra cost upon request. Many self-help tools are available.

Your Advantage

Your Advantage means that Agilent offers a wide range of additional expert test and measurement services, which you can purchase according to your unique technical and business needs. Solve problems efficiently and gain a competitive edge by contracting with us for calibration, extra-cost upgrades, out-of-warranty repairs, and on-site education and training, as well as design, system integration, project management, and other professional engineering services. Experienced Agilent engineers and technicians worldwide can help you maximize your productivity, optimize the return on investment of your Agilent instruments and systems, and obtain dependable measurement accuracy for the life of those products.

By internet, phone, or fax, get assistance with all your test & measurement needs.

Online assistance:

www.agilent.com/comms/lightwave

Phone or Fax

United States:

(tel) 1 800 452 4844

Canada:

(tel) 1 877 894 4414

(fax) (905) 282 6495

Europe:

(tel) (31 20) 547 2323

(fax) (31 20) 547 2390

Japan:

(tel) (81) 426 56 7832

(fax) (81) 426 56 7840

Latin America:

(tel) (305) 269 7500

(fax) (305) 269 7599

Australia:

(tel) 1 800 629 485

(fax) (61 3) 9210 5947

New Zealand:

(tel) 0 800 738 378

(fax) 64 4 495 8950

Asia Pacific:

(tel) (852) 3197 7777

(fax) (852) 2506 9284

Product specifications and descriptions in this document subject to change without notice.

Copyright © 1999, 2001 Agilent Technologies

Printed in USA February 1, 2001

5968-5587E



Agilent Technologies

Innovating the HP Way